

REID®

Display Manual
Ladies Classic eBike
Gents Classic eBike
E Scape
E Trail 1.0
Quest 1.0
Blacktop 1.0



Contents

Product name and model.....	1
Specifications.....	1
Appearance and dimension.....	1
Function and button definition.....	2
◆ Function summary.....	2
◆ Function layout.....	2
◆ Button definition.....	2
Installation.....	3
General operations.....	3
◆ Switch E-bike system ON/OFF.....	3
◆ Display interface.....	3
◆ Switch push-assistance mode ON/OFF.....	4
◆ Switch lighting ON/OFF.....	4
◆ Assist level selection.....	5
◆ Battery indicator.....	5
◆ Error code indication.....	6
General Settings.....	6
◆ Trip distance clearance.....	6
◆ Backlight brightness.....	7
◆ Toggle the unit KM/miles.....	7
General parameters settings.....	8
◆ Wheel diameter.....	8
◆ Speed limit.....	8
Personalized parameters settings.....	9
◆ Battery power bar settings.....	10
◆ Assist level settings.....	10
Assist level mode options.....	10
Assist level ratio settings.....	11
◆ Controller over-current cut settings(optional).....	11
◆ Power assist sensor settings(optional).....	12
PAS direction settings.....	12
PAS sensitivity settings.....	12
PAS magnet quantity settings.....	13

◆ Speed sensor settings(optional).....	13
◆ Throttle function settings(optional).....	14
Throttle push assist enable/disable settings.....	14
Throttle level enable/disable settings.....	14
◆ System settings (optional)	15
Battery power delay time settings.....	15
Maximum speed limits.....	15
Push assist button enable/disable.....	16
Slow start up settings.....	16
◆ Power-on password settings.....	17
Power-on password Enable/Disable.....	17
Power-on password change.....	18
◆ Exit settings.....	18
Recover default settings.....	19
Quality assurance and warranty scope.....	19
Wire connection layout.....	20
Warnings.....	20
Attached list 1: Error code definitions.....	21
Attached list 2: Personalized settings symbols.....	21
Attached list 2: Assist level ratio defaults.....	21
Attached list 4: Other symbols.....	21

Product name and model

E-bike Intelligent LCD Display
Model: KD21C.

Specifications

- 24V/36V/48V Power Supply
- Rated working current: 10mA
- The maximum working current: 30mA
- Off-state leakage current: <math><1\mu\text{A}</math>
- Working temperature: $-20^{\circ}\text{C} \sim 60^{\circ}\text{C}$
- Storage temperature: $-30^{\circ}\text{C} \sim 70^{\circ}\text{C}$

Appearance and Size

Product appearance and dimensional drawing (unit: mm)

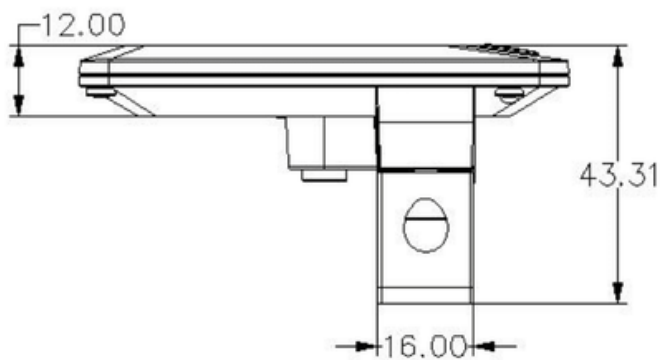
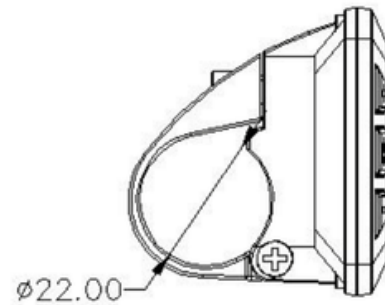
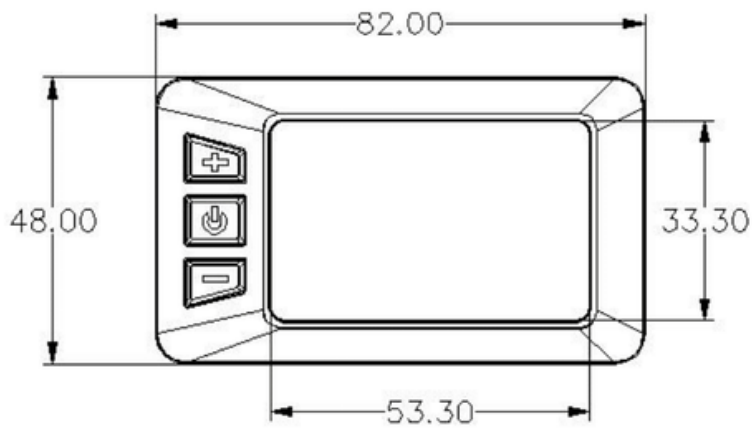

Function Summary and Button Definition

◆Function Summary

KD21C has many functions to meet riders' needs. The indication elements are as follows:

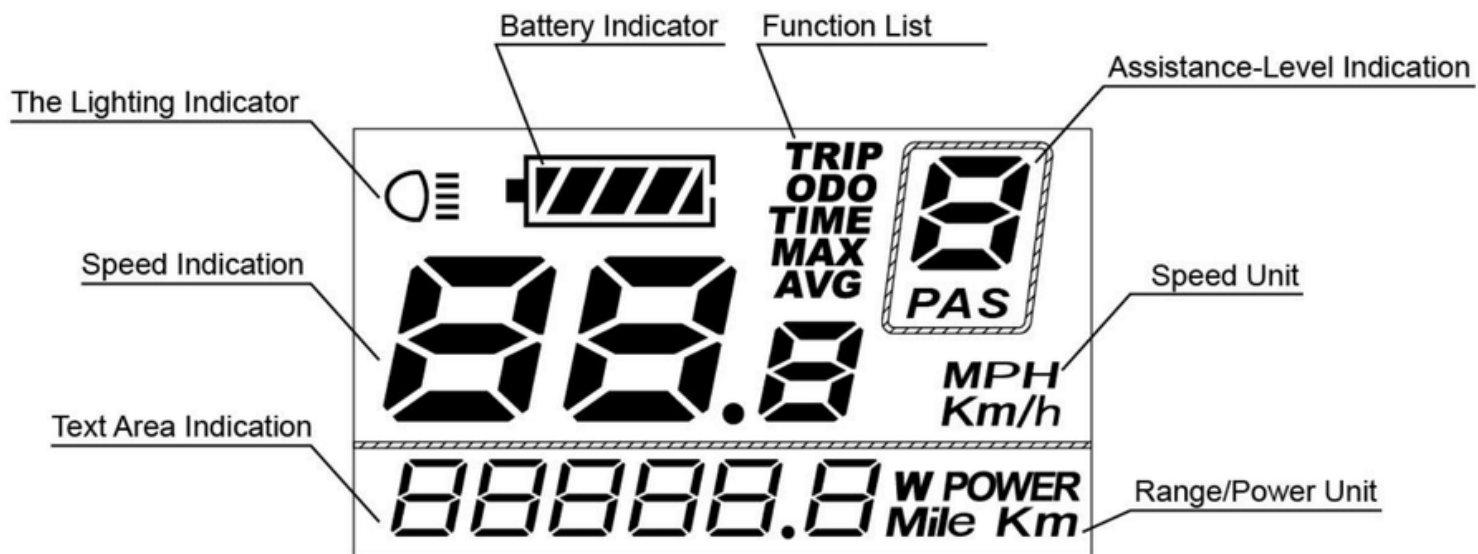

- Battery level
- Motor output power
- Assist level
- Speed indication (incl. current speed, Max. speed and Avg. speed)
- ODO and Trip
- Push-assistance function
- Trip time
- Backlight ON/OFF
- Error code indication
- Various Parameters Settings (e.g. wheel diameter, speed limit, battery power bar, assist level, current limit, maximum speed, password enable, etc.)
- Recover Default Settings

◆Functional Area Distribution



Functional Area Distribution

◆Button Definition

There are three buttons ( ,  , ) on KD21C display. In this manual, we use words **ON/OFF**,

UP, DOWN to represent these 3 symbols ( ,  , ) .

Installation

KD21C can be mounted on the left side of handlebar close to its grip. Adjust the angle for a good screen view. Cut off the power before connecting the corresponding connectors between display and controller.

General Operation

◆ Switching the E-bike System mode ON/OFF

To switch on the E-bike system and provide the power supply to the controller, hold the On/Off button for 2s.

To switch off E-bike system, hold the On/Off button for 2s. The E-bike system no longer uses the battery power.

When E-bike system is switched off, the leakage current is less than 1 μ A.

■ When the E-bike is parked for approx. 10 minutes, the E-bike system switches off automatically.

◆ Display Interface

After switching on the E-bike system, the display shows Current Speed and ODO(total distance) by default.

Press the **ON/OFF** button to switch between indication functions below:

ODO (Km)→ Trip (Km) → Trip Time (Hour) → Motor Power (W)→ODO (Km)→ Max. Speed (Km/h)→ Avg. Speed (Km/h) , it cycles back to ODO km again.

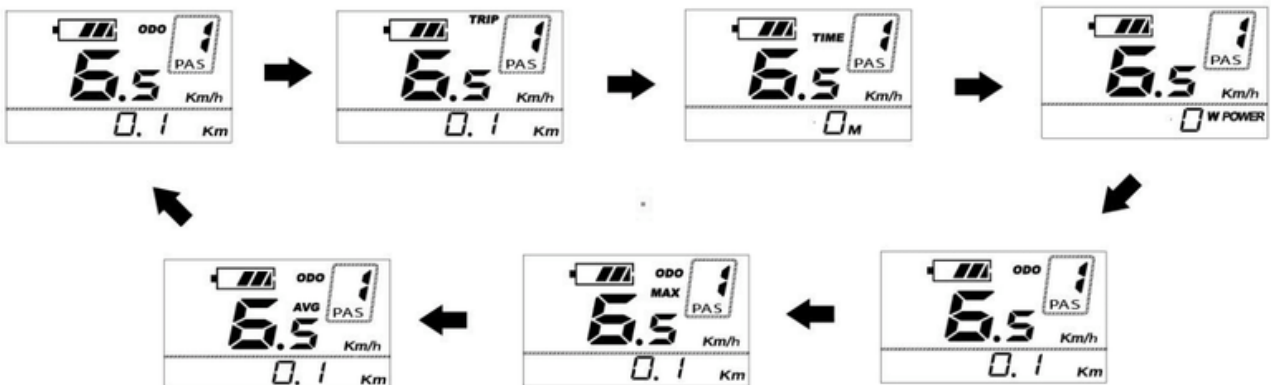

Display indication cycle interface

◆ Switching Push-assistance mode ON/OFF

To activate the push-assistance function, press and hold the **DOWN** button. After 2 seconds, E-bike is activated to go at a uniform speed of 6 Km/h while the screen displays “P”.

The push-assistance function will be switched off as soon as you release the **DOWN** button.

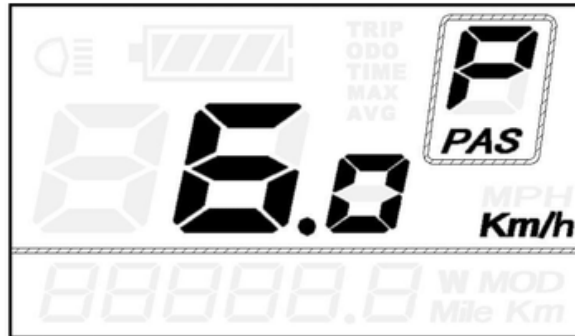

Push-assistance mode

■ Push-assistance function may only be used when pushing the E-bike. Be aware of danger of injury when bike wheels do not have ground contact while using the push-assistance function.

◆ Switching Lighting ON/OFF

To switch on E-bike front light or rear light, press the “UP” button for 2s. The display backlight brightness is automatically reduced while the screen displays “”.

Likewise, press the “UP” button for 2s again, the bike front light and rear light can be switched off and display backlight recover its brightness.

*If E-bike front light or rear light is independent of “UP” button, the “UP” button can only be used to switch on/off the display backlight.

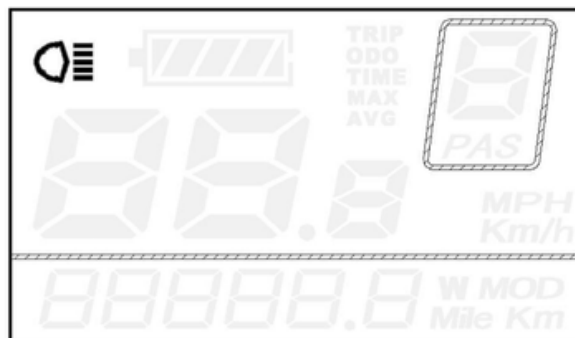

Switching Lighting on/off

◆ Assist Level Selection

The assist level of the E-bike drive can be changed anytime, even during riding.

The assist level ranges from 0 to 5 (level 0 to level 5). The default assist level is “1” when the display is started. The output power is zero on Level “0”. Level “1” is the minimum output power. Level “5” is the maximum output power.

Press **UP/DOWN** button to switch between the E-bike system assist levels and change the motor output power.

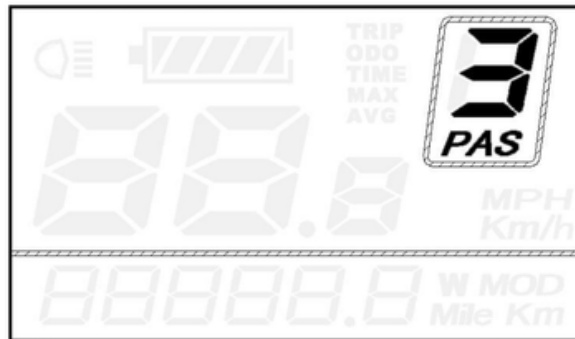

Assist Level “3”

◆ Manual clearance functions

Amid all indication functions, Trip Distance, Max Speed and Avg. Speed can only be cleared manually.

If the above functions need to be cleared, hold **ON/OFF** button and the **DOWN** button for 2s, the above functions can be cleared simultaneously.

◆ Battery Indicator

The five battery power bars represent the capacity of the battery. The five battery bars are bright when the battery is in full voltage. When the battery is in low voltage, battery frame will flash at the frequency of 1HZ to give a notice that the battery needs to be recharged immediately

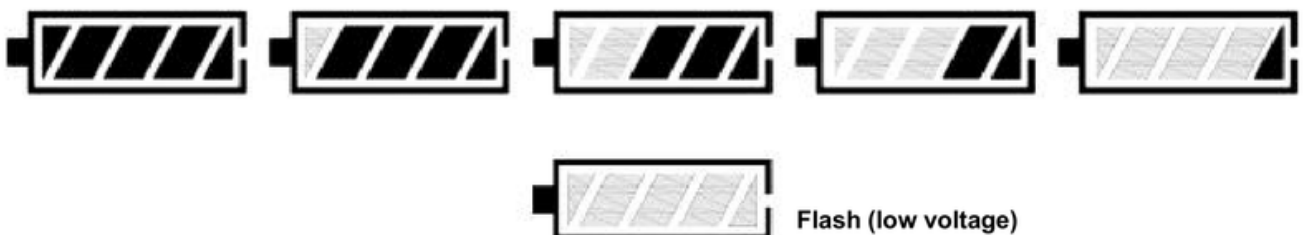

Battery Indicator

◆ Error Code Indication

The components of the E-bike system are continuously and automatically monitored.

When an error is detected, the respective error code is indicated in text indication area.

Refer to detailed definition of the error codes in **Attached list 1**.

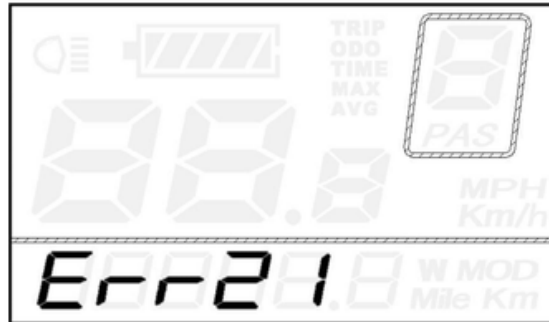

Error Code Indication

■ **Have the display inspected and repaired when an error code appears. Or else, you will not be able to ride the bike normally. Please always refer to an authorized bicycle dealer.**

General Settings

After the E-bike system is switched on, hold both the **UP** button and **DOWN** button simultaneously for 2s to access general settings menu.

■ **All the Settings are completed on a parked E-bike.**

◆ Trip Distance Clearance

TC represents trip distance clearance settings.

Press the **UP/DOWN** button to choose Y or N. The default value is N.

To store a changed setting, press the **ON/OFF** button and access backlight settings.

For symbols and their definitions, please refer to **Attached list 4**.

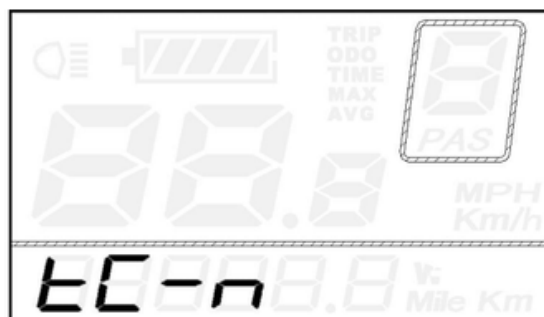

Trip Distance Clearance Settings Interface

◆ Backlight settings

bL represents backlight settings. Level “1” is the lowest brightness. Level “2” is the medium brightness. Level “3” is the highest brightness. The default value is “1”.

To change the backlight brightness, press the **UP/DOWN** button to increase or decrease until the desired brightness is displayed.

To store a changed setting, press the **ON/OFF** button and access unit toggling settings.

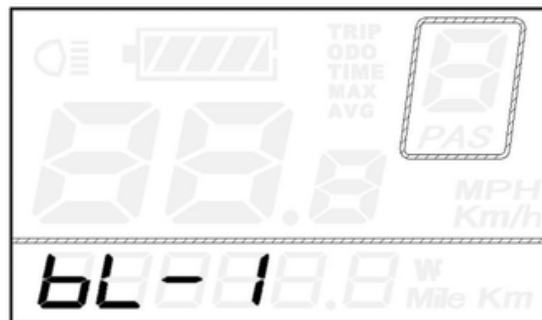

Backlight Brightness Setting Interface

◆ Unit km/mi toggling

U represents unit settings, “1” is mile, and “2” is kilometer. The default value is “2”.

To toggle the unit, press the **UP/DOWN** button until the desired unit is displayed.

To store a changed setting, press the **ON/OFF** button and access trip distance clearance settings again or hold the **ON/OFF** button for 2s to exit **General Settings**.

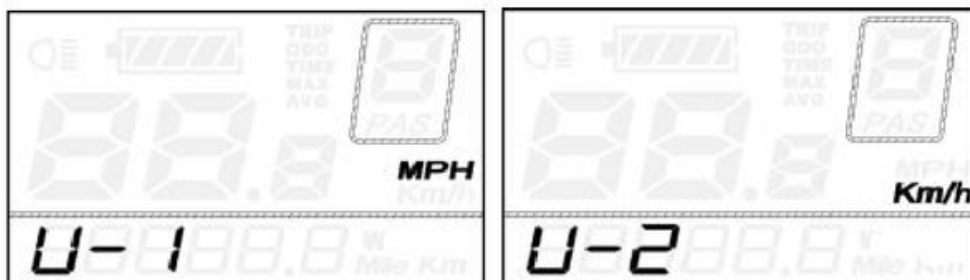

Mile and Kilometer toggling Settings Interface

General Parameter Settings

To access general parameter settings interface, hold both the **UP** and the **DOWN** button simultaneously for 2s to enter **General Settings**, then hold both the **DOWN** and **ON/OFF** button for 2s again to enter **General Parameter Settings**.

◆Wheel Diameter Settings

Ld represents wheel diameter settings. Optional values are 16, 18, 20, 22, 24, 26, 700C and 28. The default value is 20 inch.

Press the **UP/DOWN** button to increase or decrease wheel diameter until the desired value is displayed.

To store a changed setting, press **ON/OFF** button and access speed-limit settings interface.

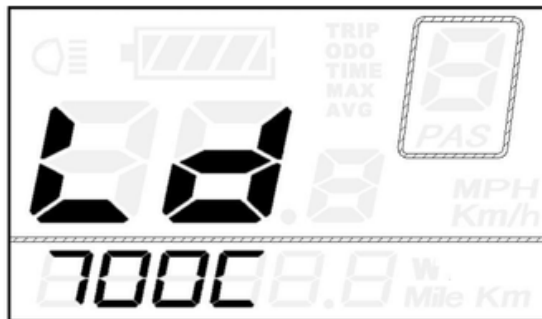

Wheel Diameter Settings Interface

◆Speed limit Settings

LS represents the speed limit settings. When the current speed is faster than speed limit, the E-bike system will be switched off automatically. Speed limit ranges from 12Km/h to 40Km/h. The default value is 25Km/h.

Press the **UP/DOWN** button to increase or decrease the speed limit values until the desired one is displayed.

To store a changed setting, press **ON/OFF** button and access wheel diameter setting again or hold the **ON/OFF** button for 2s to exit **General Parameter Settings**.

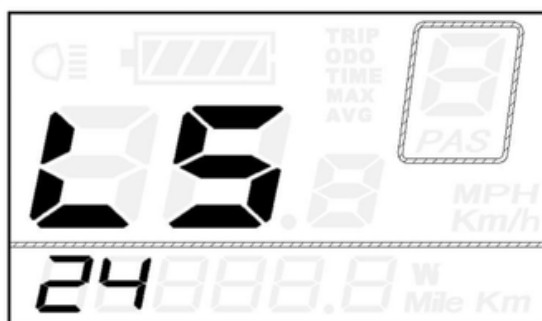

Speed Limit Settings Interface

Personalized Parameter Settings

Personalized Parameter Settings can meet a variety of riders' personalized requirements. 8 settings are Battery Power Bar Settings, Power assist level Settings, Over-current Cut Settings, Power Assist Sensor Settings, Speed Sensor Settings, Throttle Function Settings, System Settings and Power-on Password Settings. Please refer to **Attached list 2** for the definition of the symbols.

Hold **UP** and **DOWN** button simultaneously for 2 seconds to enter **General Settings** and Hold **UP** and **DOWN** button simultaneously for another 2 seconds to enter **Personalized Parameter Settings** interface.

Press **UP** or **DOWN** button to choose the personalized parameter setting item, then press **ON/OFF** button to enter the corresponding setting interface.

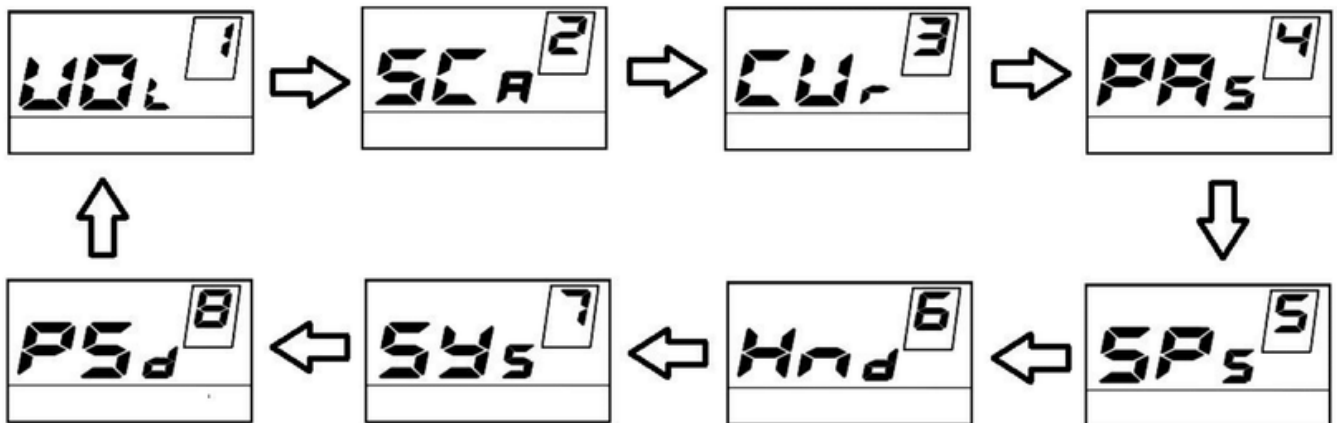

Setting Item Cycle Interface

◆ Battery Power Bar Settings

VOL represents voltage settings. Each bar represents a voltage value. Each of the 5 values is to be entered one by one. For example, VOL 1 is the first bar voltage value, the default value is 31.5V. Press **UP** or **DOWN** button to increase or decrease the bar value and press **ON/OFF** button to store a changed setting and access the second bar. Likewise, you can set the values in the same manner for other bars. After values for 5 bars are entered completely, press **ON/OFF** to confirm and return to the previous menu.

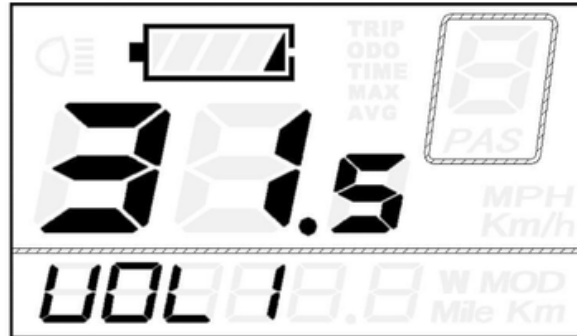

Battery Bar Settings

◆ Assist Level Settings

SCA represents assist level settings.

Assist Level mode options

There are 8 assist level modes: 0-3, 1-3, 0-5, 1-5, 0-7, 1-7, 0-9, 1-9. The default mode is 0-5.

Press the **UP/DOWN** button to increase or decrease until the desired mode is displayed.

Press the **ON/OFF** button and access the assist level ratio settings automatically.

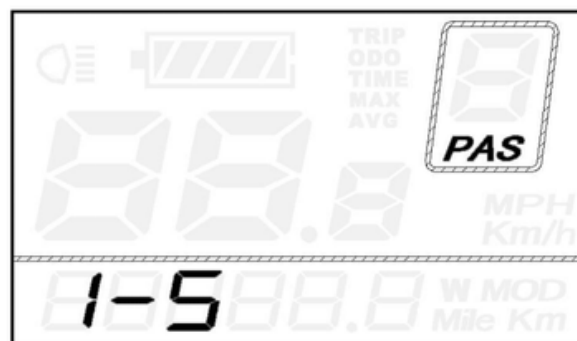

"1-5" flash

Assist Level Mode Interface

Assist Level Ratio Settings

The speed of each level can be adjusted to meet different riders' needs by setting the ratios.

For example, the default ratio is 50% for level "1"; the ratio range is 45%-55% for Level "1".

To change the ratio of a certain assist level, press the **UP/DOWN** button to choose the desired ratio value, and then press the **"ON/OFF"** button to confirm and then move to the next level ratio setting.

After ratios of all levels were input, hold the **"ON/OFF"** button for 2s to confirm and return to previous menu.

*Please refer to assist level ratio default values **Attached list 3**

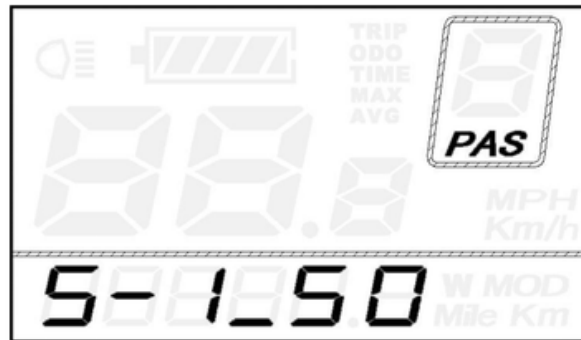

Assist Level Ratio Interface

◆ Controller Over-Current Cut Settings

CUR represents controller over-current cut settings. CUR value ranges from 7.0A to 22.0A. The default value is 15A.

Press the **UP/DOWN** button to increase or decrease the value of the current.

Press the **ON/OFF** button and then return to previous menu.

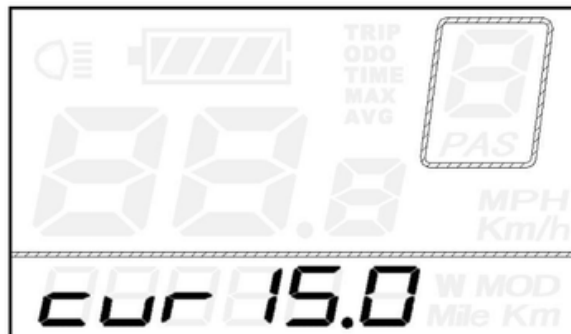

Current Settings Interface

◆ Power Assist Sensor Settings

PAS represents power assist sensor settings.

Power Assist Sensor Direction Settings

“**run-F**” means forward direction while “**run-b**” means backward direction. The default value is “**run-F**”.

Press the **UP/DOWN** button to select **F** or **b** to change the direction of Power Assist Sensor.

Press the **ON/OFF** button and then access PAS sensitivity settings.

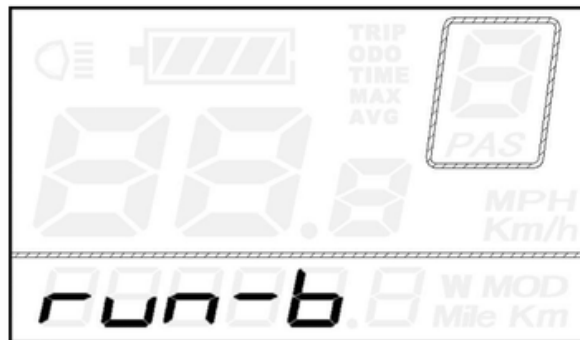

PAS Direction Settings

PAS Sensitivity Settings

SCN represents PAS sensitivity settings. The sensitivity value ranges from “2” to “9”. “2” is the strongest, “9” is the weakest. The default value is “2”.

Press the **UP/DOWN** button to choose sensitivity value to change the PAS sensitivity settings.

Press the **ON/OFF** button and then access magnet disk settings.

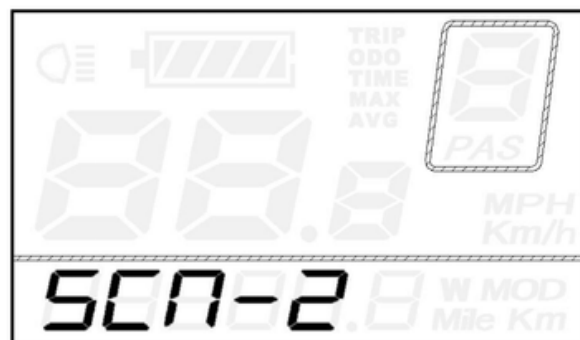

PAS sensitivity Settings

PAS Magnet Quantity Settings

N represents the number of magnets on PAS disk. The default value is 12.

Press the **UP/DOWN** button to select the number of magnets on PAS disk.

Hold the **ON/OFF** button for 2s to confirm and return to previous menu.

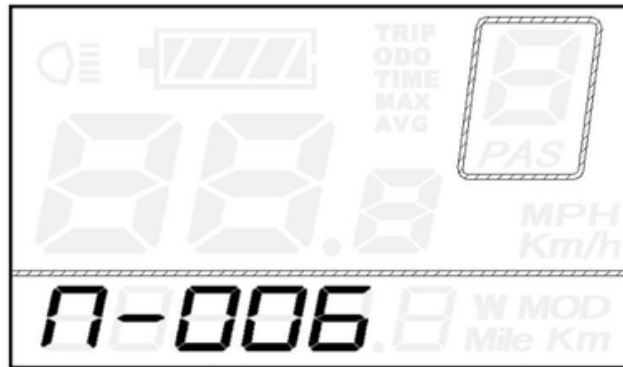

PAS Disk Magnet Quantity settings

◆ Speed Sensor Settings

SPS represents speed sensor settings. The default value is 1.

Press the **UP/DOWN** button to choose the number of spoke magnets on the bike wheel. The range is from 1 to 9.

Hold the **ON/OFF** button for 2s to confirm and then return to previous menu.

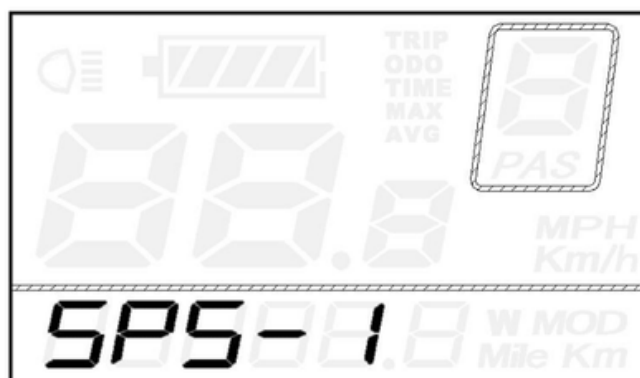

Speed Sensor settings

◆ Throttle Function Settings

Throttle Push-assistance Enable/Disable

HL represents throttle push-assistance function. **HL-N** means throttle push-assistance function is disabled. **HL-y** means throttle push-assistance function is enabled. The default value is **HL-N**.

Press the **UP/DOWN** button to select **Y** or **N** to enable or disable throttle push-assistance function .

To enable throttle push-assistance, select **Y** and hold **ON/OFF** button for 2s to confirm and return to previous menu.

To disable throttle push-assistance, select **N** and access Throttle Level Enable/Disable Setting below

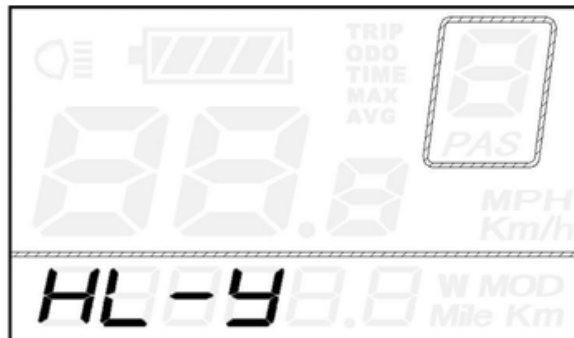

Throttle Push-assistance Enable/Disable Interface

Throttle Level Enable/Disable

HF-y means throttle speed is limited by current power assist level while **HF-n** means throttle speed is not limited by current power assist level. The default value is **n**. Press **UP/DOWN** to set **y** or **n**.

If you choose **y**, the maximum speed can only be the highest speed powered by current power assist level when you twist the throttle.

If you choose **n**, the maximum speed is not limited by current power assist level and you can override whatever level you are in and reach rated maximum speed when you twist the throttle.

To store a changed setting, press **ON/OFF** button to confirm and return to throttle push-assistance enable/disable setting interface or hold **ON/OFF** button for 2s to confirm and return to previous menu.

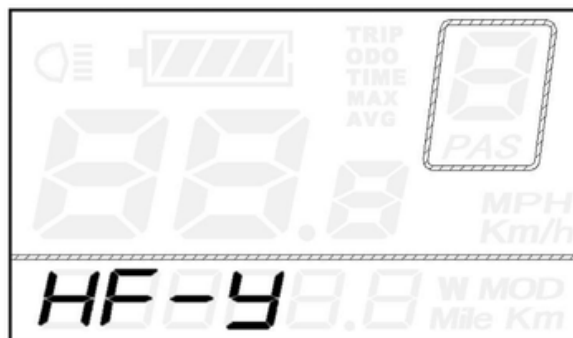

Throttle Level Enable or Disable Interface

◆ System Settings

Delay time settings for battery power

DLY represents battery power delay time settings. The default value is 3s.

Press the **UP/DOWN** button to choose delay time 3s, 6s, 12s to change the settings.

Press the **ON/OFF** button to confirm and access the max speed limit settings.

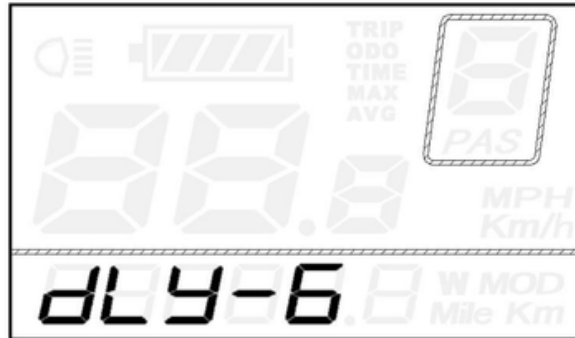

Battery power delay time Interface

Max speed limit settings

MAX SPD represents max speed limit settings. The default value is 40Km/h.

Press the **UP/DOWN** button to set the max speed from 25Km/h to 40 Km/h.

Press the **ON/OFF** button to confirm and then access Push-assist settings

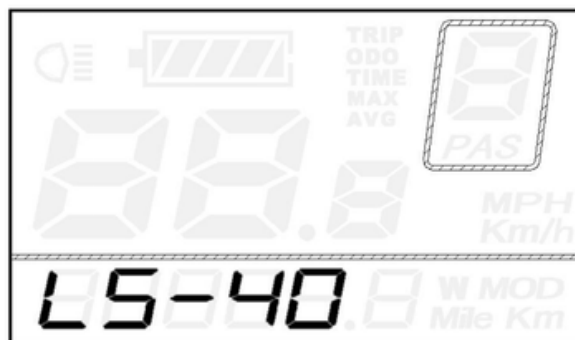

Interface of Max Speed Limit Settings

■ The maximum speed upper limit is set by the display manufacturer.

Push-assistance Enable/Disable

PUS represents push-assistance enable/disable settings. “Y” means push-assistance is enabled, “N” means push-assistance is disabled. The default value is “Y”.

Press the **UP/DOWN** button to choose “Y” or “N” to change push-assistance settings.

Press the **ON/OFF** button to confirm and then access slow start up settings.

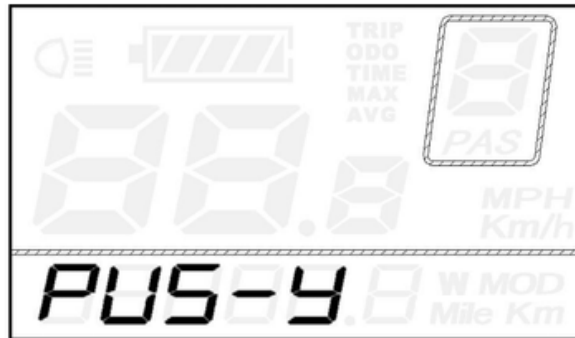

Push-assistance settings Interface

Slow Start up Settings

SSP represents slow start up. The range is “1-4”, “4” is the slowest. The default value is “1”.

To change slow start up settings, press the **UP/DOWN** button to choose the desired value.

Press the **ON/OFF** button and moves to Delay time settings for battery power.

Hold the **ON/OFF** button for 2s to return to previous menu, .

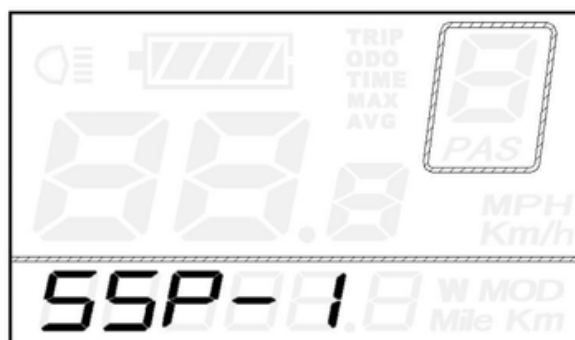

Slow Start-up Settings interface

◆ Power-on Password Settings

PSd represents power-on password settings. Power-on password is a 4-digit code. The default password is "1212".

Press **ON/OFF** button to enter the interface where "P2, 0000" is shown on the screen. Please input the current password or default password '1212'.

Press **UP/DOWN** button to increase or decrease the number and press **i** button to confirm digits one by one until the correct 4-digit password is completed. Press **ON/OFF** button to access power-on password Enable/Disable Settings.

Otherwise stay in password input state.

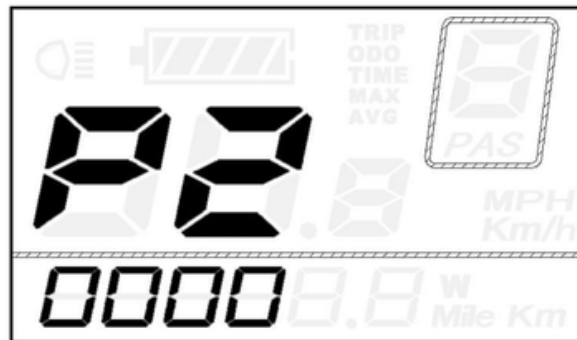

Password Input Interface

Power-on Password Enable/Disable

Press **UP** or **DOWN** button to choose Y or N and press **i** button to confirm. Y means power-on password is enabled. N means power-on password is disabled. The default value is N.

If you choose Y, press the "i" button and then access power-on password change interface.

If you choose N, you will exit the power-on password settings interface and return to previous menu.

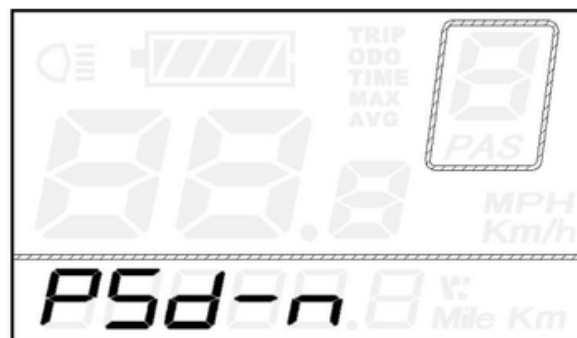

Power-on Password Disable Interface

Power-on Password Change

When the display shows P3, 0000, press **UP/DOWN** to change the number and then press **ON/OFF** button to confirm digits one by one until a new 4-digit password is completed.

To store the new power-on password, hold **ON/OFF** button for 2 s and then exit settings.

When you switch on the E-bike system next time, the display will show P1,0000, please input the new password to power on.

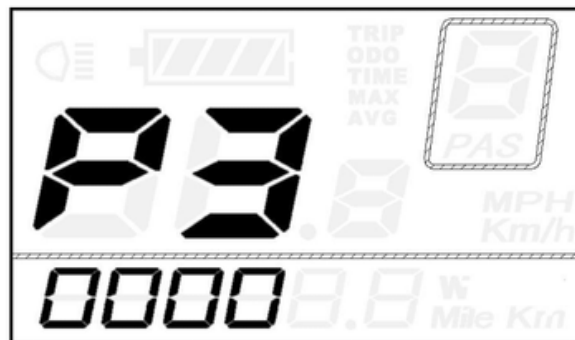

Power-on Password Change Interface

◆ Exit settings

In personalized parameter settings interface,

Press the **ON/OFF** button is to confirm the input.

Hold the **ON/OFF** button is to store the settings and exit the current setting.

Hold the **DOWN** button is to cancel the operations but not to store setting data and return to previous menu.

■ If there is no operations in one minute, the display will exit the settings interface.

Recover default settings

dEF represents recovering default settings. The default value is N.

To access recover default settings, hold both **UP** and **ON/OFF** button for 2s and then access selection interface. Press the **UP/DOWN** button to choose “Y” or “N”. “N” means not recovering default settings. Y means recovering default settings.

When it is “Y”, hold the **ON/OFF** button for 2s to recover default settings, the display shows DEF-00 at the same time and returns to display start-up page .

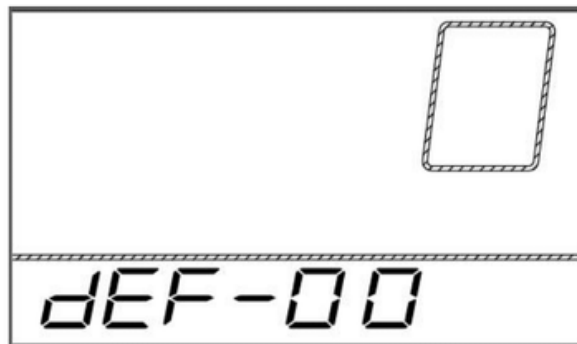

Recover Default Settings Interface

Quality assurance and warranty scope

I Warranty

- 1) The warranty will be valid only for products used in normal usage and conditions.
- 2) The warranty is valid for 24 months after the shipment or delivery to the customer.

II Others

The following cases do not belong to warranty scope:

- 1) The display is demolished.
- 2) The damage of the display is caused by wrong installation or operation.
- 3) The shell of the display is broken after the display is out of the factory.
- 4) The cable of the display is broken.
- 5) Beyond warranty period.
- 6) The fault or damage of the display is caused by the force majeure (e.g., fire, earthquake, etc.)

Connection layout

Connector wire sequence

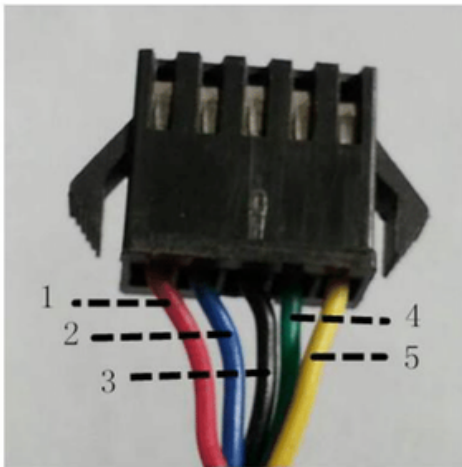

Connector to controller

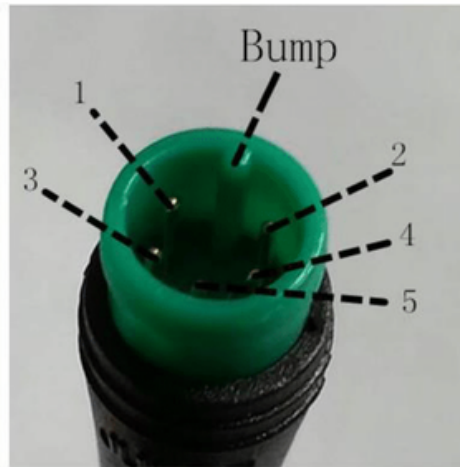

display end

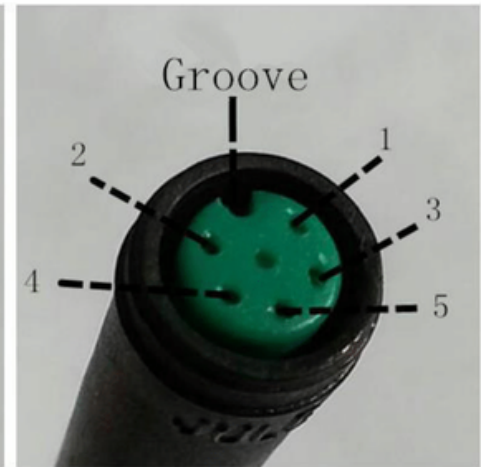

connection wire end to display end

Wire sequence table

Wire sequence	Color	Function
1	Red(VCC)	+
2	Blue(K)	Lock
3	Black(GND)	-
4	Green(RX)	RX
5	Yellow(TX)	TX

■ Some displays have wire connection with water-proof connectors, users can not see the color of lead wires in the harness.

Warnings:

1. Use the display with caution. Don't attempt to release or link the connector when battery is power on.
2. Try to avoid hitting the display.
3. Don't modify system parameters to avoid parameter disorder.
4. Make the display repaired when error code appears.

■ This manual instruction is a universal version for **DISPLAY KD21C**. Some versions of this display may be different from specification to specification as to the software. Please always refer to an actual version.

Attached list 1: Error code definition

Error Code	Definition
21	Current Abnormality
22	Throttle Abnormality
23	Motor Phase Abnormality
24	Motor Hall Signal Abnormality
25	Brake Abnormality
30	Communication Abnormality

Attached list 2: Personalized Parameter settings

No.	Settings item	Symbol
1	Battery Power Bar Settings	<i>UD_L</i>
2	Power assistant level Settings	<i>SC_R</i>
3	Over-current Cut Settings	<i>CU_r</i>
4	Power Assistant Sensor Settings	<i>PA_S</i>
5	Speed Sensor Settings	<i>SP_S</i>
6	Throttle Function Settings	<i>Fn_d</i>
7	System Settings	<i>SY_S</i>
8	Power-on Password Settings	<i>PS_d</i>

Attached list 3: Assist level ratio defaults

Level PAS Level mode	1	2	3	4	5	6	7	8	9
0-3/1-3	50%	74%	92%	—	—	—	—	—	—
0-5/ 1-5	50%	61%	73%	85%	96%	—	—	—	—
0-7/ 1-7	40%	50%	60%	70%	80%	90%	96%	—	—
0-9/ 1-9	25%	34%	43%	52%	61%	70%	79%	88%	96%

Attached list 4: Other symbols

No.	Symbol	Definition
1	<i>EC</i>	Trip distance clearance
2	<i>BL</i>	Backlight
3	<i>U</i>	Unit
4	<i>UDL</i>	Voltage
5	<i>Ld</i>	Wheel diameter
6	<i>LS</i>	Speed limit
7	<i>cur</i>	Controller over-current cut
8	<i>run-b</i>	Backward
9	<i>run-F</i>	Forward
10	<i>SCN</i>	Sensitivity of PAS
11	<i>SPS</i>	Speed sensor
12	<i>dLY</i>	Power delayed time
13	<i>HL</i>	Throttle power assist walk
14	<i>HF</i>	Throttle-changing
15	<i>PUS</i>	Button push
16	<i>SSP</i>	Slowly start up
17	<i>PSd</i>	Password
18	<i>DEF</i>	Recover default
19	<i>y</i>	Yes
20	<i>n</i>	No

REID®

Display Manual
Ladies Classic eBike
Gents Classic eBike
E Scape
E Trail 1.0
Quest 1.0
Blacktop 1.0

